

# AKCOOL

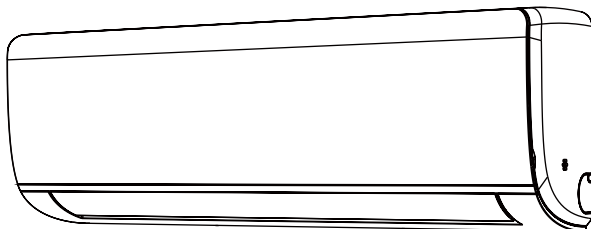

## USER'S MANUAL

Split Air Conditioner

---

*Thank you for choosing our product.*

*For proper operation, please read and keep this manual carefully.*

# Content

## Operation Notices

Precautions .....	1
Parts name.....	14

## Installation Notice

Installation drawing .....	15
Installation prepare .....	16

## Installation

Installation of indoor unit .....	19
Installation of outdoor unit.....	23
Check after installation .....	27
Test operation.....	27

## Attachment

Configuration of connection pipe.....	28
Pipe expanding method.....	29

## Operation Guide

Operation guide.....	30
Remote controller .....	31
Buttons on remote controller.....	32

## Maintenance

Clean and maintenance .....	37
-----------------------------	----

## Malfunction

Malfunction analysis.....	39
---------------------------	----



This marking indicates that this product should not be disposed with other household wastes throughout the EU. To prevent possible harm to the environment or human health from uncontrolled waste disposal, recycle it responsibly to promote the sustainable reuse of material resources. To return your used device, please use the return and collection systems or contact the retailer where the product was purchased. They can take this product for environmental safe recycling.

# Precautions

Please read this operating manual carefully before operating the unit.



Appliance filled with flammable gas R32.



Before use the appliance, read the owner's manual first.



Before install the appliance, read the installation manual first.



Before repair the appliance , read the service manual first.

The figures in this manual may be different with the material objects , please refer to the material objects for reference.

## The Refrigerant

To realize the function of the air conditioner unit, a special refrigerant circulates in the system. The used refrigerant is the fluoride R32, which is specially cleaned. The refrigerant is flammable and inodorous. Furthermore, it can leads to explosion under certain condition. But the flammability of the refrigerant is very low. It can be ignited only by fire.

Compared to common refrigerants, R32 is a nonpolluting refrigerant with no harm to the ozonosphere. The influence upon the greenhouse effect is also lower. R32 has got very good thermodynamic features which lead to a really high energy efficiency. The units therefore need a less filling.

### WARNING:

Do not use means to accelerate the defrosting process or to clean, other than those recommended by the manufacture. Should repair be necessary, contact your nearest authorized Service Centre.

Any repairs carried out by unqualified personnel may be dangerous.

The appliance shall be stored in a room without continuously operating ignition sources. (For example: open flames, an operating gas appliance or an operating electric heater.) Do not pierce or burn.

Appliance shall be installed, operated and stored in a room with a floor area larger than "X" m<sup>2</sup> (see table 1). (only applies to appliances that are not fixed appliances)

Appliance filled with flammable gas R32. For repairs, strictly follow manufacturer's instructions only.

Be aware that refrigerants not contain odour.

Read specialist's manual.



# Precautions



WARNING

## *Operation and Maintenance*

**This appliance is not intended for use by persons (including children) with reduced physical, sensory or mental capabilities, or lack of experience and knowledge, unless they have been given supervision or instruction concerning use of the appliance by a person responsible for their safety.**

**Children should be supervised to ensure that they do not play with the appliance.**

**Cleaning and user maintenance shall not be made by children without supervision.**

**Do not connect air conditioner to multi-purpose socket. Otherwise, it may cause fire hazard.**

**Do disconnect power supply when cleaning air conditioner. Otherwise, it may cause electric shock.**

**If the supply cord is damaged, it must be replaced by the manufacturer, its service agent or similarly qualified persons in order to avoid a hazard.**

**Do not wash the air conditioner with water to avoid electric shock.**

**Do not spray water on indoor unit. It may cause electric shock or malfunction.**

**After removing the filter, do not touch fins to avoid injury.**

**Do not use fire or hair dryer to dry the filter to avoid deformation or fire hazard.**

**Maintenance must be performed by qualified professionals. Otherwise, it may cause personal injury or damage.**

**Do not repair air conditioner by yourself. It may cause electric shock or damage. Please contact dealer when you need to repair air conditioner.**

**Do not extend fingers or objects into air inlet or air outlet. It may cause personal injury or damage.**

# Precautions



## WARNING

**Do not block air outlet or air inlet. It may cause malfunction.**

**Do not spill water on the remote controller, otherwise the remote controller may be broken.**

**When below phenomenon occurs, please turn off air conditioner and disconnect power immediately, and then contact the dealer or qualified professionals for service.**

- Power cord is overheating or damaged.
- There's abnormal sound during operation.
- Circuit break trips off frequently.
- Air conditioner gives off burning smell.
- Indoor unit is leaking.

**If the air conditioner operates under abnormal conditions, it may cause malfunction, electric shock or fire hazard.**

**When turning on or turning off the unit by emergency operation switch, please press this switch with an insulating object other than metal.**

**Do not step on top panel of outdoor unit, or put heavy objects. It may cause damage or personal injury.**

### Attachment

**Installation must be performed by qualified professionals. Otherwise, it may cause personal injury or damage.**

**Must follow the electric safety regulations when installing the unit.**

**According to the local safety regulations, use qualified power supply circuit and circuit break.**

**Do install the circuit break. If not, it may cause malfunction.**

**An all-pole disconnection switch having a contact separation of at least 3mm in all poles should be connected in fixed wiring.**

**Air Conditioner should be properly grounded. Incorrect grounding may cause electric shock.**

# Precautions



## WARNING

Including an circuit break with suitable capacity, please note the following table. Air switch should be included magnet buckle and heating buckle function, it can protect the circuit-short and overload.

**Don't use unqualified power cord.**

**Make sure the power supply matches with the requirement of air conditioner. Unstable power supply or incorrect wiring or malfunction. Please install proper power supply cables before using the air conditioner.**

**Properly connect the live wire, neutral wire and grounding wire of power socket.**

**Be sure to cut off the power supply before proceeding any work related to electricity and safety.**

**Do not put through the power before finishing installation.**

**If the supply cord is damaged, it must be replaced by the manufacturer, its service agent or similarly qualified persons in order to avoid a hazard.**

**The temperature of refrigerant circuit will be high, please keep the interconnection cable away from the copper tube.**

**The appliance shall be installed in accordance with national wiring regulations.**

**Fuse of indoor unit: T3.15A 250V AC or T5A 250V AC, please refer to the screen printing on the circuit board for the actual parameters. which must be consistent with the parameters on the screen printing.**

**For 9K-12K models, fuse of outdoor unit: T15A 250V AC or T20A 250V AC.**

**For 18K models, fuse of outdoor unit: T20A 250V AC or T25A 250V AC.**

**Installation must be performed in accordance with the requirement of NEC and CEC by authorized personnel only.**

# Precautions



The air conditioner is the first class electric appliance. It must be properly grounded with specialized grounding device by a professional. Please make sure it is always grounded effectively, otherwise it may cause electric shock.

The yellow-green wire in air conditioner is grounding wire, which can't be used for other purposes.

The grounding resistance should comply with national electric safety regulations.

The appliance must be positioned so that the plug is accessible.

All wires of indoor unit and outdoor unit should be connected by a professional.

If the length of power connection wire is insufficient, please contact the supplier for a new one. Avoid extending the wire by yourself.

For the air conditioner with plug, the plug should be reachable after finishing installation.

For the air conditioner without plug, an circuit break must be installed in the line.

If you need to relocate the air conditioner to another place, only the qualified person can perform the work. Otherwise, it may cause personal injury or damage.

Select a location which is out of reach for children and far away from animals or plants. If it is unavoidable, please add the fence for safety purpose.

The indoor unit should be installed close to the wall.



## Qualification requirement for installation and maintenance man

All the work men who are engaging in the refrigeration system should bear the valid certification awarded by the authoritative organization and the qualification for dealing with the refrigeration system recognized by this industry. If it needs other technician to maintain and repair the appliance, they should be supervised by the person who bears the qualification for using the flammable refrigerant.

It can only be repaired by the method suggested by the equipment's manufacturer.

# Precautions



## WARNING

### *Working temperature range*

	Indoor side DB/WB(°C)	Outdoor side DB/WB(°C)
Maximum cooling	32/23	46/30
Maximum heating	27/-	24/18

The operating temperature range (outdoor temperature) for cooling only unit is 18°C~ 46°C, for heat pump unit is -15°C~ 46°C.

#### **WARNING**

Do not use means to accelerate the defrosting process or to clean, other than those recommended by the manufacturer.

The appliance shall be stored in a room without continuously operating ignition sources (for example: open flames, an operating gas appliance or an operating electric heater).

Do not pierce or burn.

Be aware that refrigerants may not contain an odour.

The installation of pipe-work shall be kept to a minimum.

That pipe-work shall be protected from physical damage and shall not be installed in an unventilated space.

That compliance with national gas regulations shall be observed.

That mechanical connections made shall be accessible for maintenance purposes.

Keep any required ventilation openings clear of obstruction.

Servicing shall be performed only as recommended by the manufacturer.

#### **Checks to the area**

Prior to beginning work on systems containing flammable refrigerants, safety checks are necessary to ensure that the risk of ignition is minimised. For repair to the refrigerating system, the following precautions shall be completed prior to conducting work on the system.

#### **Work procedure**

Work shall be undertaken under a controlled procedure so as to minimise the risk of a flammable gas or vapour being present while the work is being performed.

#### **General work area**

All maintenance staff and others working in the local area shall be instructed on the nature of work being carried out. Work in confined spaces shall be avoided.

#### **Checking for presence of refrigerant**

The area shall be checked with an appropriate refrigerant detector prior to and during work, to ensure the technician is aware of potentially toxic or flammable atmospheres. Ensure that the leak detection equipment being used is suitable for use with all applicable refrigerants, i.e. non-sparking, adequately sealed or intrinsically safe.

# Precautions



## WARNING

### **Presence of fire extinguisher**

If any hot work is to be conducted on the refrigerating equipment or any associated parts, appropriate fire extinguishing equipment shall be available to hand. Have a dry powder or CO<sub>2</sub> fire extinguisher adjacent to the charging area.

### **No ignition sources**

No person carrying out work in relation to a refrigerating system which involves exposing any pipe work shall use any sources of ignition in such a manner that it may lead to the risk of fire or explosion. All possible ignition sources, including cigarette smoking, should be kept sufficiently far away from the site of installation, repairing, removing and disposal, during which refrigerant can possibly be released to the surrounding space. Prior to work taking place, the area around the equipment is to be surveyed to make sure that there are no flammable hazards or ignition risks. "No Smoking" signs shall be displayed.

### **Ventilated area**

Ensure that the area is in the open or that it is adequately ventilated before breaking into the system or conducting any hot work. A degree of ventilation shall continue during the period that the work is carried out. The ventilation should safely disperse any released refrigerant and preferably expel it externally into the atmosphere.

### **Checks to the refrigerating equipment**

Where electrical components are being changed, they shall be fit for the purpose and to the correct specification. At all times the manufacturer's maintenance and service guidelines shall be followed. If in doubt, consult the manufacturer's technical department for assistance.

The following checks shall be applied to installations using flammable refrigerants:

- the actual refrigerant charge is in accordance with the room size within which the refrigerant containing parts are installed;
- the ventilation machinery and outlets are operating adequately and are not obstructed;
- if an indirect refrigerating circuit is being used, the secondary circuit shall be checked for the presence of refrigerant;
- marking to the equipment continues to be visible and legible. Markings and signs that are illegible shall be corrected;
- refrigerating pipe or components are installed in a position where they are unlikely to be exposed to any substance which may corrode refrigerant containing components, unless the components are constructed of materials which are inherently resistant to being corroded or are suitably protected against being so corroded.

### **Checks to electrical devices**

Repair and maintenance to electrical components shall include initial safety checks and component inspection procedures. If a fault exists that could compromise safety, then no electrical supply shall be connected to the circuit until it is satisfactorily dealt with. If the fault cannot be corrected immediately but it is necessary to continue operation, an adequate temporary solution shall be used. This shall be reported to the owner of the equipment so all parties are advised.

# Precautions



## WARNING

Initial safety checks shall include:

- that capacitors are discharged: this shall be done in a safe manner to avoid possibility of sparking;
- that no live electrical components and wiring are exposed while charging, recovering or purging the system;
- that there is continuity of earth bonding.

### Repairs to sealed components

During repairs to sealed components, all electrical supplies shall be disconnected from the equipment being worked upon prior to any removal of sealed covers, etc. If it is absolutely necessary to have an electrical supply to equipment during servicing, then a permanently operating form of leak detection shall be located at the most critical point to warn of a potentially hazardous situation.

Particular attention shall be paid to the following to ensure that by working on electrical components, the casing is not altered in such a way that the level of protection is affected. This shall include damage to cables, excessive number of connections, terminals not made to original specification, damage to seals, incorrect fitting of glands, etc.

Ensure that the apparatus is mounted securely.

Ensure that seals or sealing materials have not degraded to the point that they no longer serve the purpose of preventing the ingress of flammable atmospheres. Replacement parts shall be in accordance with the manufacturer's specifications.

### Repair to intrinsically safe components

Do not apply any permanent inductive or capacitance loads to the circuit without ensuring that this will not exceed the permissible voltage and current permitted for the equipment in use.

Intrinsically safe components are the only types that can be worked on while live in the presence of a flammable atmosphere. The test apparatus shall be at the correct rating.

Replace components only with parts specified by the manufacturer. Other parts may result in the ignition of refrigerant in the atmosphere from a leak.

### Cabling

Check that cabling will not be subject to wear, corrosion, excessive pressure, vibration, sharp edges or any other adverse environmental effects. The check shall also take into account the effects of aging or continual vibration from sources such as compressors or fans.

### Detection of flammable refrigerants

Under no circumstances shall potential sources of ignition be used in the searching for or detection of refrigerant leaks. A halide torch (or any other detector using a naked flame) shall not be used.

The following leak detection methods are deemed acceptable for all refrigerant systems.

Electronic leak detectors may be used to detect refrigerant leaks but, in the case of flammable refrigerants, the sensitivity may not be adequate, or may need re-calibration.

(Detection equipment shall be calibrated in a refrigerant-free area.) Ensure that the detector is not a potential source of ignition and is suitable for the refrigerant used. Leak detection equipment shall be set at a percentage of the LFL of the refrigerant and shall be calibrated to the refrigerant employed, and the appropriate percentage of gas (25 % maximum) is confirmed.

# Precautions



## WARNING

Leak detection fluids are also suitable for use with most refrigerants but the use of detergents containing chlorine shall be avoided as the chlorine may react with the refrigerant and corrode the copper pipe-work.

If a leak is suspected, all naked flames shall be removed/extinguished.

If a leakage of refrigerant is found which requires brazing, all of the refrigerant shall be recovered from the system, or isolated (by means of shut off valves) in a part of the system remote from the leak. Removal of refrigerant shall be according to Removal and evacuation.

### Removal and evacuation

When breaking into the refrigerant circuit to make repairs – or for any other purpose – conventional procedures shall be used. However, for flammable refrigerants it is important that best practice is followed since flammability is a consideration. The following procedure shall be adhered to:

- remove refrigerant;
- purge the circuit with inert gas;
- evacuate;
- purge with inert gas;
- open the circuit by cutting or brazing.

The refrigerant charge shall be recovered into the correct recovery cylinders. For appliances containing flammable refrigerants other than A2L refrigerants, the system shall be purged with oxygen-free nitrogen to render the appliance safe for flammable refrigerants. This process may need to be repeated several times. Compressed air or oxygen shall not be used for purging refrigerant systems.

For appliances containing flammable refrigerants, other than A2L refrigerants, refrigerants purging shall be achieved by breaking the vacuum in the system with oxygen-free nitrogen and continuing to fill until the working pressure is achieved, then venting to atmosphere, and finally pulling down to a vacuum. This process shall be repeated until no refrigerant is within the system. When the final oxygen-free nitrogen charge is used, the system shall be vented down to atmospheric pressure to enable work to take place. This operation is absolutely vital if brazing operations on the pipe-work are to take place.

Ensure that the outlet for the vacuum pump is not close to any potential ignition sources and that ventilation is available.

### Charging procedures

In addition to conventional charging procedures, the following requirements shall be followed.

- Ensure that contamination of different refrigerants does not occur when using charging equipment. Hoses or lines shall be as short as possible to minimise the amount of refrigerant contained in them.
- Cylinders shall be kept in an appropriate position according to the instructions.
- Ensure that the refrigerating system is earthed prior to charging the system with refrigerant.

# Precautions



## WARNING

- Label the system when charging is complete (if not already).
  - Extreme care shall be taken not to overfill the refrigerating system.
- Prior to recharging the system, it shall be pressure-tested with the appropriate purging gas. The system shall be leak-tested on completion of charging but prior to commissioning. A follow up leak test shall be carried out prior to leaving the site.

### Decommissioning

Before carrying out this procedure, it is essential that the technician is completely familiar with the equipment and all its detail. It is recommended good practice that all refrigerants are recovered safely. Prior to the task being carried out, an oil and refrigerant sample shall be taken in case analysis is required prior to re-use of recovered refrigerant. It is essential that electrical power is available before the task is commenced.

- a) Become familiar with the equipment and its operation.
- b) Isolate system electrically.
- c) Before attempting the procedure, ensure that:
  - mechanical handling equipment is available, if required, for handling refrigerant cylinders;
  - all personal protective equipment is available and being used correctly;
  - the recovery process is supervised at all times by a competent person;
  - recovery equipment and cylinders conform to the appropriate standards.
- d) Pump down refrigerant system, if possible.
- e) If a vacuum is not possible, make a manifold so that refrigerant can be removed from various parts of the system.
- f) Make sure that cylinder is situated on the scales before recovery takes place.
- g) Start the recovery machine and operate in accordance with instructions.
- h) Do not overfill cylinders (no more than 80 % volume liquid charge).
- i) Do not exceed the maximum working pressure of the cylinder, even temporarily.
- j) When the cylinders have been filled correctly and the process completed, make sure that the cylinders and the equipment are removed from site promptly and all isolation valves on the equipment are closed off.
- k) Recovered refrigerant shall not be charged into another refrigerating system unless it has been cleaned and checked.

### Labelling

Equipment shall be labelled stating that it has been de-commissioned and emptied of refrigerant. The label shall be dated and signed. For appliances containing flammable refrigerants, ensure that there are labels on the equipment stating the equipment contains flammable refrigerant.

### Recovery

When removing refrigerant from a system, either for servicing or decommissioning, it is recommended good practice that all refrigerants are removed safely.

# Precautions



## WARNING

When transferring refrigerant into cylinders, ensure that only appropriate refrigerant recovery cylinders are employed. Ensure that the correct number of cylinders for holding the total system charge is available. All cylinders to be used are designated for the recovered refrigerant and labelled for that refrigerant (i.e. special cylinders for the recovery of refrigerant). Cylinders shall be complete with pressure-relief valve and associated shut-off valves in good working order. Empty recovery cylinders are evacuated and, if possible, cooled before recovery occurs.

The recovery equipment shall be in good working order with a set of instructions concerning the equipment that is at hand and shall be suitable for the recovery of all appropriate refrigerants including, when applicable, flammable refrigerants. In addition, a set of calibrated weighing scales shall be available and in good working order. Hoses shall be complete with leak-free disconnect couplings and in good condition. Before using the recovery machine, check that it is in satisfactory working order, has been properly maintained and that any associated electrical components are sealed to prevent ignition in the event of a refrigerant release. Consult manufacturer if in doubt.

The recovered refrigerant shall be returned to the refrigerant supplier in the correct recovery cylinder, and the relevant waste transfer note arranged. Do not mix refrigerants in recovery units and especially not in cylinders.

If compressors or compressor oils are to be removed, ensure that they have been evacuated to an acceptable level to make certain that flammable refrigerant does not remain within the lubricant. The evacuation process shall be carried out prior to returning the compressor to the suppliers. Only electric heating to the compressor body shall be employed to accelerate this process. When oil is drained from a system, it shall be carried out safely.

This unit is equipped with electrically powered safety measures. To be effective, the unit must be electrically powered at all times after installation, other than when servicing.

# Safety operation of flammable refrigerant

## Qualification requirement for installation and maintenance man

All the work men who are engaging in the refrigeration system should bear the valid certification awarded by the authoritative organization and the qualification for dealing with the refrigeration system recognized by this industry. If it needs other technician to maintain and repair the appliance, they should be supervised by the person who bears the qualification for using the flammable refrigerant. It can only be repaired by the method suggested by the equipment's manufacturer.

## Installation notes

1. The air conditioner is not allowed to use in a room that has running fire (such as fire source, working coal gas ware, operating heater).
2. It is not allowed to drill hole or burn the connection pipe.
3. The air conditioner must be installed in a room that is larger than the minimum room area. The minimum room area is shown on the nameplate or following table 1.
4. Leak test is a must after installation.

Table 1: Minimum room area (m<sup>2</sup>)

Minimum room area (m <sup>2</sup> )	Charge amount (kg)	≤1.2	1.3	1.4	1.5	1.6	1.7	1.8	1.9	2.0	2.1	2.2	2.3	2.4	2.5
	Floor location	/	14.5	16.8	19.3	22.0	24.8	27.8	31.0	34.4	37.8	41.5	45.4	49.4	53.6
	Window mounted	/	5.2	6.1	7.0	7.9	8.9	10.0	11.2	12.4	13.6	15	16.3	17.8	19.3
	Wall mounted	/	1.6	1.9	2.1	2.4	2.8	3.1	3.4	3.8	4.2	4.6	5	5.5	6.0
	Ceiling mounted	/	1.1	1.3	1.4	1.6	1.8	2.1	2.3	2.6	2.8	3.1	3.4	3.7	4.0

## Maintenance notes

**Check whether the maintenance area or the room area meet the requirement of the nameplate.**

— It's only allowed to be operated in the rooms that meet the requirement of the nameplate.

**Check whether the maintenance area is well-ventilated.**

— The continuous ventilation status should be kept during the operation process.

**Check whether there is fire source or potential fire source in the maintenance area.**

— The naked flame is prohibited in the maintenance area; and the "no smoking" warning board should be hanged.

**Check whether the appliance mark is in good condition.**

— Replace the vague or damaged warning mark.

# Safety operation of flammable refrigerant

## Welding

If you should cut or weld the refrigerant system pipes in the process of maintaining, please follow the steps as below:

1. Shut down the unit and cut power supply.
2. Eliminate the refrigerant.
3. Vacuuming.
4. Clean it with N2 gas.
5. Cutting or welding.
6. Carry back to the service spot for welding.

The refrigerant should be recycled into the specialized storage tank.

Make sure that there isn't any naked flame near the outlet of the vacuum pump and it's well-ventilated.

## Filling the refrigerant

1. Use the refrigerant filling appliances specialized for R32. Make sure that different kinds of refrigerant won't contaminate with each other.
2. The refrigerant tank should be kept upright at the time of filling refrigerant.
3. Stick the label on the system after filling is finished (or haven't finished).
4. Don't overfilling.
5. After filling is finished, please do the leakage detection before test running; another time of leak detection should be done when it's removed.

## Safety instructions for transportation and storage

1. Please use the flammable gas detector to check before unload and open the container.
2. No fire source and smoking.
3. According to the local rules and laws.

# Parts name

## Indoor unit

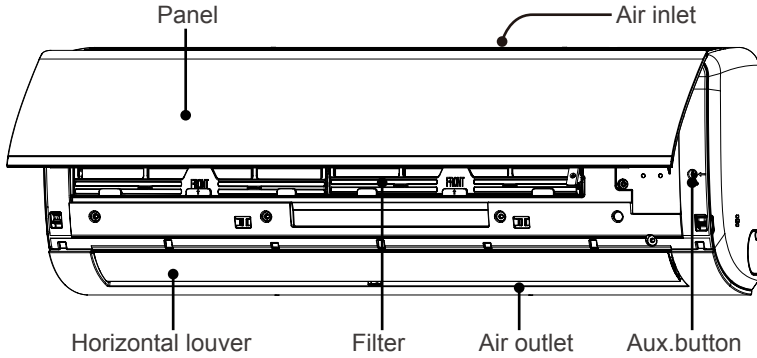

## Outdoor unit

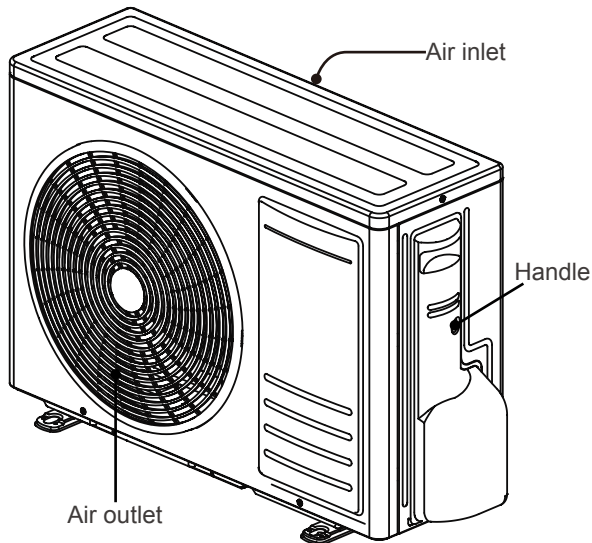

**NOTE:**

Actual product may be different from above graphics, please refer to actual products.

# Installation drawing

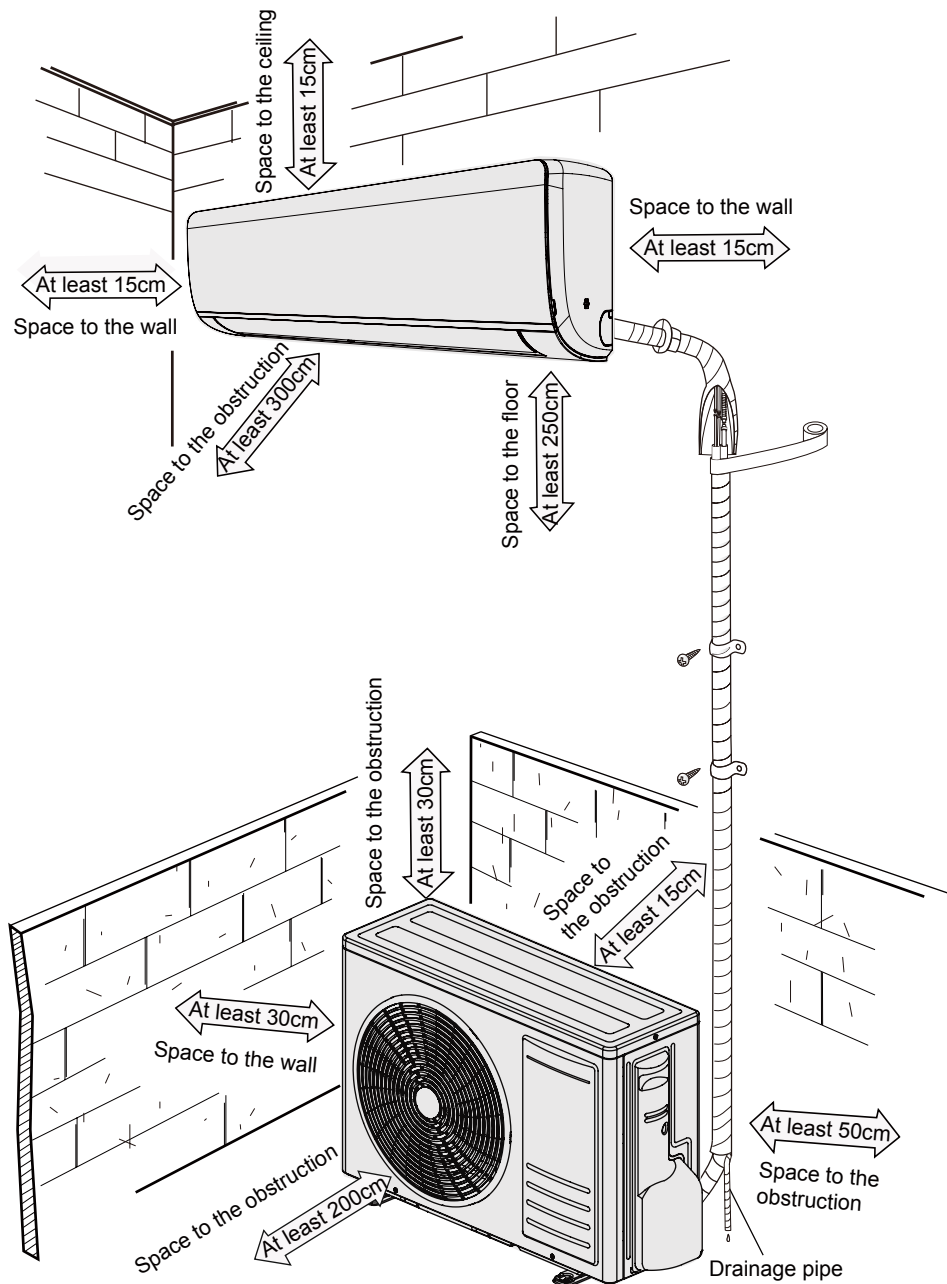

# Installation prepare

## Tools

1 Level meter	2 Screw driver	3 Impact drill
4 Drill head	5 Pipe expander	6 Torque wrench
7 Open-end wrench	8 Pipe cutter	9 Leakage detector
10 Vacuum pump	11 Pressure meter	12 Universal meter
13 Inner hexagon spanner		14 Measuring tape

## Selection of location

### Basic requirement

Installing the unit in the following places may cause malfunction. If it is unavoidable, please consult the local dealer:

1. The place with strong heat sources, vapors, flammable or explosive gas, or volatile objects spread in the air.
2. The place with high-frequency devices (such as welding machine, medical equipment).
3. The place near coast area.
4. The place with oil or fumes in the air.
5. The place with sulfureted gas.
6. Other places with special circumstances.
7. The appliance shall not be installed in the laundry.

### Indoor unit

1. There should be no obstruction near air inlet and air outlet.
2. Select a location where the condensation water can be dispersed easily and won't affect other people.
3. Select a location which is convenient to connect the outdoor unit and near the power socket.
4. Select a location which is out of reach for children.
5. The location should be able to withstand the weight of indoor unit and won't increase noise and vibration.
6. The appliance must be installed 2.5m above floor.
7. Don't install the indoor unit right above the electric appliance.
8. Please try your best to keep away from fluorescent lamp.

### Outdoor unit

1. Select a location where the noise and out flow air emitted by the outdoor unit will not affect neighborhood.
2. The location should be well ventilated and dry, in which the outdoor unit won't be exposed directly to sunlight or strong wind.
3. The location should be able to withstand the weight of outdoor unit.
4. Make sure that the installation follows the requirement of installation dimension diagram.
5. Select a location which is out of reach for children and far away from animals or plants. If it is unavoidable, please add the fence for safety purpose.

# Installation prepare

## Safety precaution

1. Must follow the electric safety regulations when installing the unit.
2. According to the local safety regulations, use qualified power supply circuit and circuit break.
3. Make sure the power supply matches with the requirement of air conditioner. Unstable power supply or incorrect wiring or malfunction. Please install proper power supply cables before using the air conditioner.
4. Properly connect the live wire, neutral wire and grounding wire of power socket.
5. Be sure to cut off the power supply before proceeding any work related to electricity and safety.
6. Do not connect the power before finishing inatallation.
7. If the supply cord is damaged, it must be replaced by the manufacturer, its service agent or similarly qualified persons in order to avoid a hazard.
8. The temperature of refrigerant circuit will be high, please keep the interconnection cable away from the copper tube.
9. The appliance shall be installed in accordance with national wiring regulations.
10. Installation must be performed in accordance with the requirement of NEC and CEC by authorized personnel only.
11. Appliance shall be installed, operated and stored in a room with a floor area larger than "X"m<sup>2</sup> (see table 1).



Please notice that the unit is filled with flammable gas R32. Inappropriate treatment of the unit involves the risk of severe damages of people and material. Details to this refrigerant are found in chapter "refrigerant".

## Grounding requirement

1. The air conditioner is the first class electric appliance. It must be properly grounding with specialized grounding device by a professional. Please make sure it is always grounded effectively, otherwise it may cause electric shock.
2. The yellow-green wire in air conditioner is grounding wire, which can't be used for other purposes.
3. The grounding resistance should comply with national electric safety regulations.
4. The appliance must be positioned so that the plug is accessible.
5. The appliance must be fitted with means for disconnection from the supply mains having a contact separation in all poles that provide full disconnection under overvoltage category III conditions, and these means must be incorporated in the fixed wiring in accordance with the wiring rules.
6. Including an circuit break with suitable capacity, please note the following table. Circuit break should be included magnet buckle and heating buckle function, it can protect the circuit-short and overload. (Caution: please do not use the fuse only for protect the circuit)

Air-conditioner	Circuit break capacity
09K、12K	10A
18K、24K	25A

# Installation prepare

## *Safety precautions for installing and relocating the unit*

To ensure safety, please be mindful of the following precautions.



### **WARNING**

- 1. When installing or relocating the unit, be sure to keep the refrigerant circuit free from air or substances other than the specified refrigerant.**
  - Any presence of air or other foreign substance in the refrigerant circuit will cause system pressure rise or compressor rupture, resulting in injury.
- 2. When installing or moving this unit, do not charge the refrigerant which is not comply with that on the nameplate or unqualified refrigerant.**
  - Otherwise, it may cause abnormal operation, wrong action, mechanical malfunction or even series safety accident.
- 3. When refrigerant needs to be recovered during relocating or repairing the unit, be sure that the unit is running in cooling mode. Then, fully close the valve at high pressure side (liquid valve). About 30-40 seconds later, fully close the valve at low pressure side (gas valve), immediately stop the unit and disconnect power. Please note that the time for refrigerant recovery should not exceed 1 minute.**
  - If refrigerant recovery takes too much time, air may be sucked in and cause pressure rise or compressor rupture, resulting in injury.
- 4. During refrigerant recovery, make sure that liquid valve and gas valve are fully closed and power is disconnected before detaching the connection pipe.**
  - If compressor starts running when stop valve is open and connection pipe is not yet connected, air will be sucked in and cause pressure rise or compressor rupture, resulting in injury.
- 5. When installing the unit, make sure that connection pipe is securely connected before the compressor starts running.**
  - If compressor starts running when stop valve is open and connection pipe is not yet connected, air will be sucked in and cause pressure rise or compressor rupture, resulting in injury.
- 6. Prohibit installing the unit at the place where there may be leaked corrosive gas or flammable gas.**
  - If there leaked gas around the unit, it may cause explosion and other accidents.
- 7. Do not use extension cords for electrical connections. If the electric wire is not long enough, please contact a local service center authorized and ask for a proper electric wire.**
  - Poor connections may lead to electric shock or fire.
- 8. Use the specified types of wires for electrical connections between the indoor and outdoor units. Firmly clamp the wires so that their terminals receive no external stresses.**
  - Electric wires with insufficient capacity, wrong wire connections and insecure wire terminals may cause electric shock or fire.

# Installation of indoor unit

## Step 1: Choosing installation location

Recommend the installation location to the client and then confirm it with the client.

## Step 2: Install wall-mounting frame

1. Hang the wall-mounting frame on the wall; adjust it in horizontal position with the level meter and then point out the screw fixing holes on the wall .
2. Drill the screw fixing holes on the wall with impact drill (the specification of drill head should be the same as the plastic expansion particle) and then fill the plastic expansion particles in the holes.
3. Fix the wall-mounting frame on the wall with tapping screws (ST4.2X25TA) and then check if the frame is firmly installed by pulling the frame. If the plastic expansion particle is loose, please drill another fixing hole nearby.

## Step 3: Open piping hole

1. Choose the position of piping hole according to the direction of outlet pipe. The position of piping hole should be a little lower than the wall-mounted frame, shown as below.

Dimension: 721x274x195 or 743x278x194

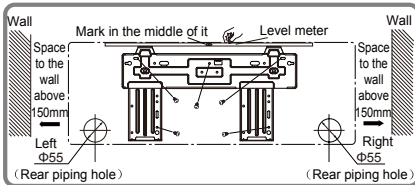

Dimension: 792x279x195 or 821x283x200

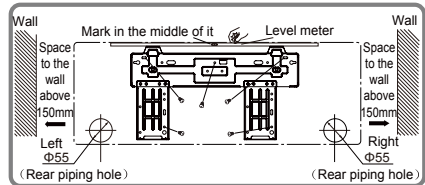

Dimension: 850x291x203 or 884x298x205

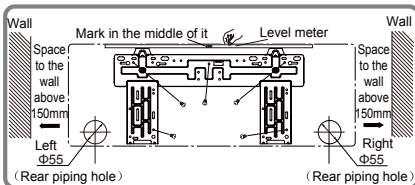

Dimension: 972x302x224 or 1003x310x222

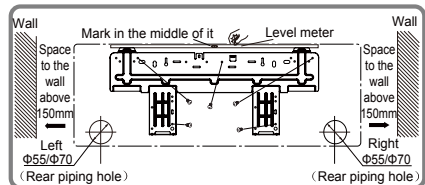

Dimension: 1081x327x248 or 1109x331x250

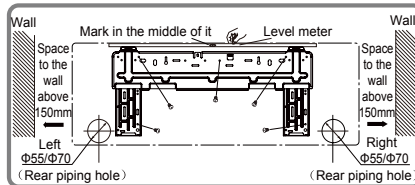

# Installation of indoor unit

- Open a piping hole with the diameter of  $\Phi 55/\Phi 70$  on the selected outlet pipe position. In order to drain smoothly, slant the piping hole on the wall slightly downward to the outdoor side with the gradient of  $5\sim 10^\circ$ .

**Note:**

- Pay attention to dust prevention and take relevant safety measures when opening the hole.
- The plastic expansion particles are not provided and should be bought locally.

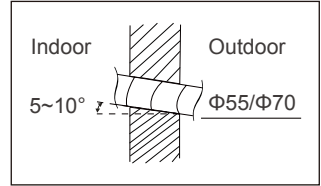

## Step 4: Outlet pipe

- The pipe can be led out in the direction of right, rear right or left.

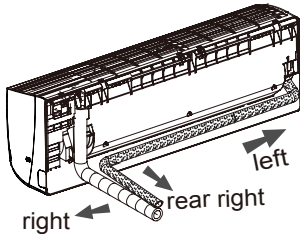

- When select leading out the pipe from left or right, please cut off the corresponding hole on the bottom case.

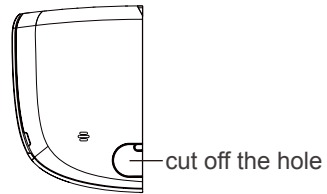

## Step 5: Connect the pipe of indoor unit

- Aim the pipe joint at the corresponding bellmouth.
- Pretightening the union nut with hand.
- Adjust the torque force by referring to the following sheet. Place the open-end wrench on the pipe joint and place the torque wrench on the union nut. Tighten the union nut with torque wrench.

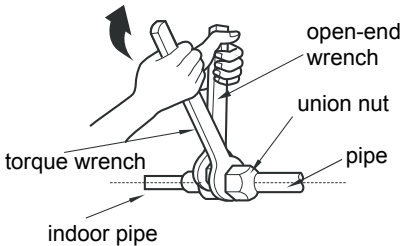
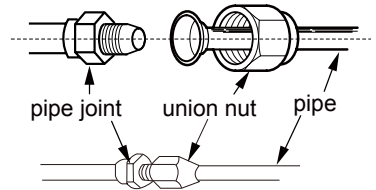

Hex nut diameter	Tightening torque (N·m)
$\Phi 6$	15~20
$\Phi 9.52$	30~40
$\Phi 12$	45~55
$\Phi 16$	60~65
$\Phi 19$	70~75

- Wrap the indoor pipe and joint of connection pipe with insulating pipe, and then wrap it with tape.

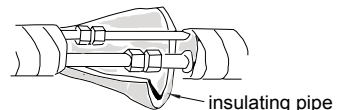

# Installation of indoor unit

## Step 6: Install drain hose

1. Connect the drain hose to the outlet pipe of indoor unit.
2. Bind the joint with tape.

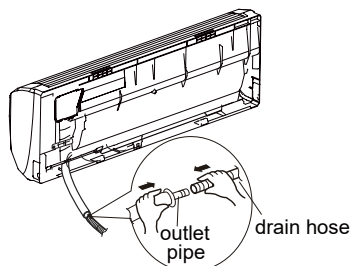
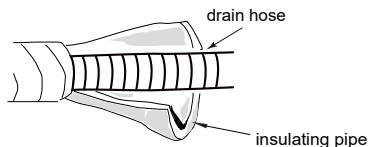
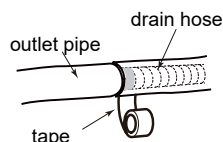

- Add insulating pipe in the indoor drain hose in order to prevent condensation.
- The plastic expansion particles are not provided.

## Step 7: Connect wire of indoor unit

1. Open the panel, remove the screw on the wiring cover and then take down the cover.

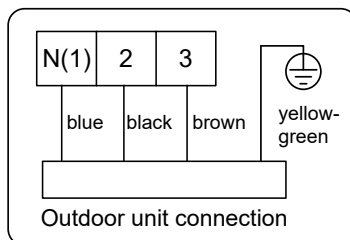
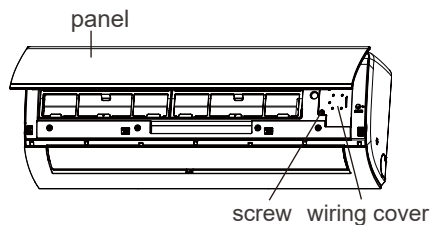

2. Make the power connection wire go through the cable-cross hole at the back of indoor unit and then pull it out from the front side.
3. Remove the wire clip, connect the power connection wire to the wiring terminal according to the color; tighten the screw and then fix the power connection wire with wire clip.
4. Put wiring cover back and then tighten the screw.
5. Close the panel.

### **Note:**

- All wires of indoor unit and outdoor unit should be connected by a professional.
- If the length of power connection wire is insufficient, please contact the supplier for a new one. Avoid extending the wire by yourself.
- For the air conditioner with plug, the plug should be reachable after finishing installation.
- For the air conditioner without plug, an air switch must be installed in the line.  
The air switch should be all-pole parting and the contact parting distance should be more than 3mm.

# Installation of indoor unit

## Step 8: Bind up pipe

1. Bind up the connection pipe, power cord and drain hose with the band.
2. Reserve a certain length of drain hose and power cord for installation when binding them. When binding to a certain degree, separate the indoor power and then separate the drain hose.

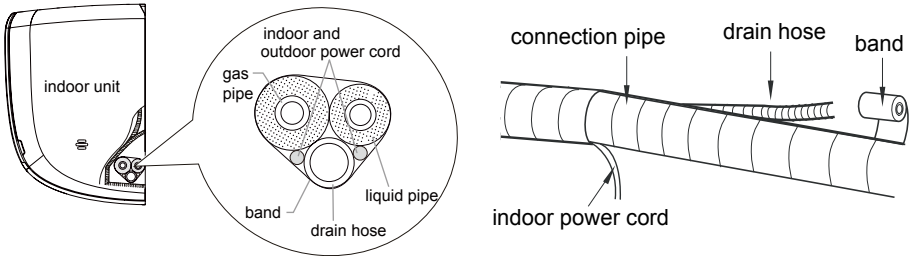

3. Bind them evenly.
4. The liquid pipe and gas pipe should be bound separately at the end.

### *Note:*

- The power cord and control wire can't be crossed or winding.
- The drain hose should be bound at the bottom.

## Step 9: Hang the indoor unit

1. Put the bound pipes in the wall pipe and then make them pass through the wall hole.
2. Hang the indoor unit on the wall-mounting frame.
3. Stuff the gap between pipes and wall hole with sealing gum.
4. Fix the wall pipe.
5. Check if the indoor unit is installed firmly and closed to the wall.

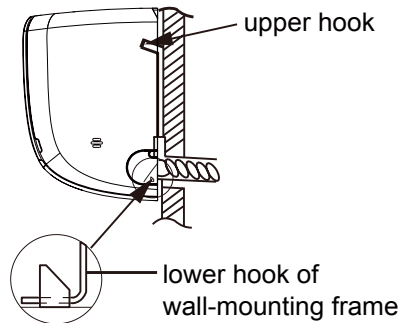
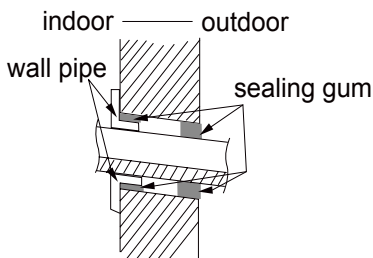

- Do not bend the drain hose too excessively in order to prevent blocking.

# Installation of outdoor unit

## Step 1: Fix the support of outdoor

Select it according to the actual installation situation

1. Select installation location according to the house structure.
2. Fix the support of outdoor unit on the selected location with expansion screws.

*Note:*

- Take sufficient protective measures when installing the outdoor unit.
- Make sure the support can withstand at least four times of the unit weight.
- The outdoor unit should be installed at least 3cm above the the floor in order to install drainjoint.
- For the unit with cooling capacity of 2300W~5000W, 6 expansion screws are needed; for the unit with cooling capacity of 6000W~8000W, 8 expansion screws are needed; for the unit with cooling capacity of 10000W ~16000W, 10 expansion screws are needed.

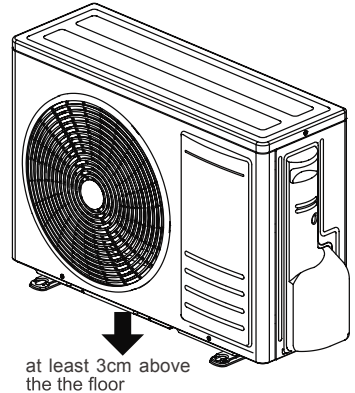

## Step 2: Install drain joint (Only for cooling and heating unit)

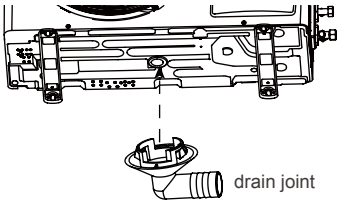

1. Connect the outdoor drain joint into the hole on the chassis, as shown in the picture below.
2. Connect the drain hose into the drain vent.

## Step 3: Fix outdoor unit

1. Place the outdoor unit on the support.
2. Fix the foot holes of outdoor unit with bolts.

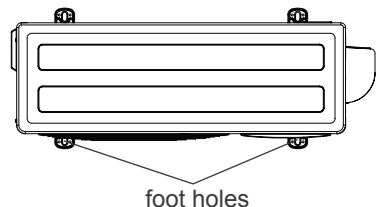

# Installation of outdoor unit

## Step 4: Connect indoor and outdoor pipe

1. Remove the screw on the right handle of outdoor unit and then remove the handle.

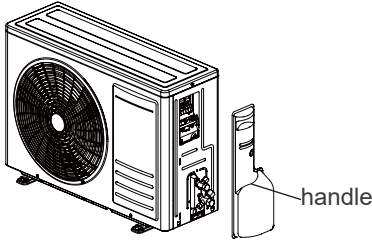

2. Remove the screw cap of valve and aim the pipe joint at the bellmouth of pipe.

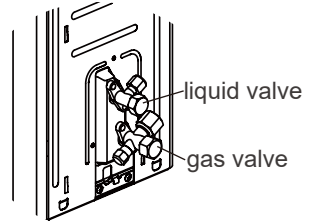

3. Pretightening the union nut with hand.

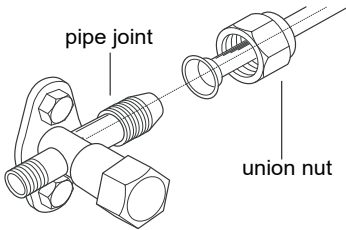

4. Tighten the union nut with torque wrench by referring to the sheet below.

Hex nut diameter	Tightening torque (N·m)
Φ 6	15~20
Φ 9.52	30~40
Φ 12	45~55
Φ 16	60~65
Φ 19	70~75

## Step 5: Connect indoor and outdoor pipe

1. Remove the wire clip; connect the power connection wire and signal control wire (only for cooling and heating unit) to the wiring terminal according to the color, fix them with screws.
2. Fix the power connection wire and signal control wire with wire clip (only for cooling and heating unit).

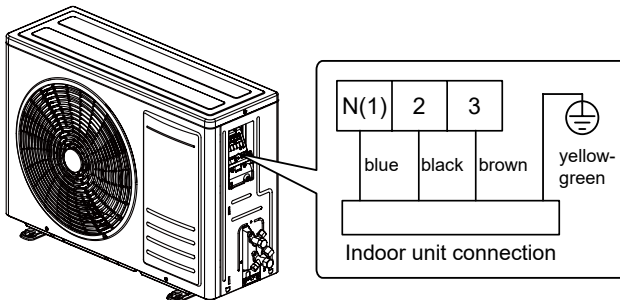

### Note:

- After tighten the screw, pull the power cord slightly to check if it is firm.
- Never cut the power connection wire to prolong or shorten the distance.

# Installation of outdoor unit

## Step 6: Neaten the pipes

1. The pipes should be placed along the wall, bent reasonably and hidden possibly. Min.semidiometer of bending the pipe is 10cm.
2. If the outdoor unit is higher than the wall hole, you must set a U-shaped curve in the pipe before pipe goes into the room, in order to prevent rain from getting into the room.

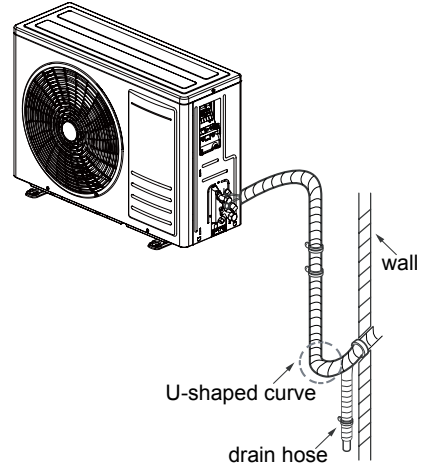

### *Note:*

- The through-wall height of drain hose shouldn't be higher than the outlet pipe hole of indoor unit.
- The water outlet can't be placed in water in order to drain smoothly.

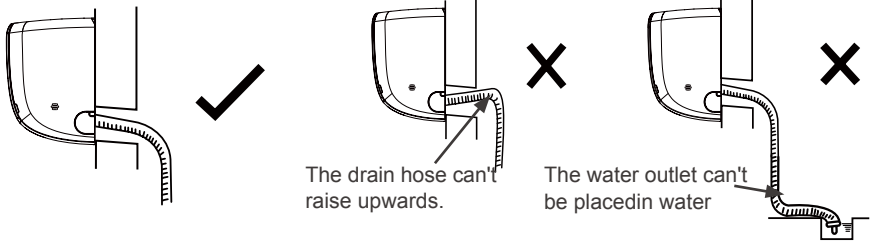

Slant the drain hose slightly downwards. The drain hose can't be curved, raised and fluctuant, etc.

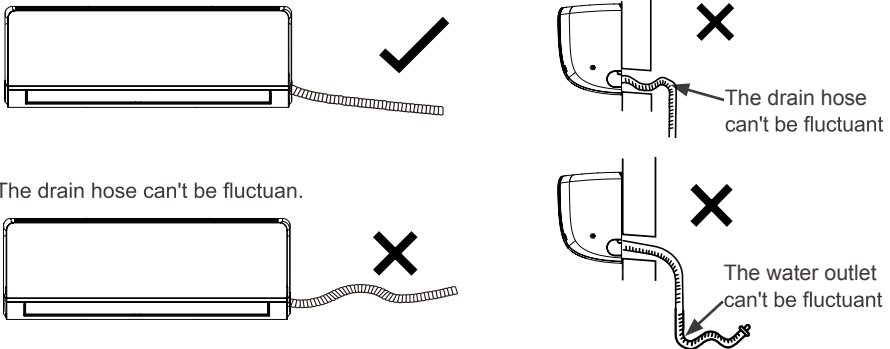

# Installation of outdoor unit

## Step 7: Vacuum pumping

### Use vacuum pump

1. Remove the valve caps on the liquid valve and gas valve and the nut of refrigerant charging vent.
2. Connect the charging hose of piezometer to the refrigerant charging vent of gas valve and then connect the other charging hose to the vacuum pump.
3. Open the piezometer completely and operate for 10-15min to check if the pressure of piezometer remains in  $-0.1\text{MPa}$ .
4. Close the vacuum pump and maintain this status for 1-2min to check if the pressure of piezometer remains in  $-0.1\text{MPa}$ . If the pressure decreases, there may be leakage.
5. Remove the piezometer, open the valve core of liquid valve and gas valve completely with inner hexagon spanner.
6. Tighten the screw caps of valve and refrigerant charging vent.
7. Reinstall the handle.

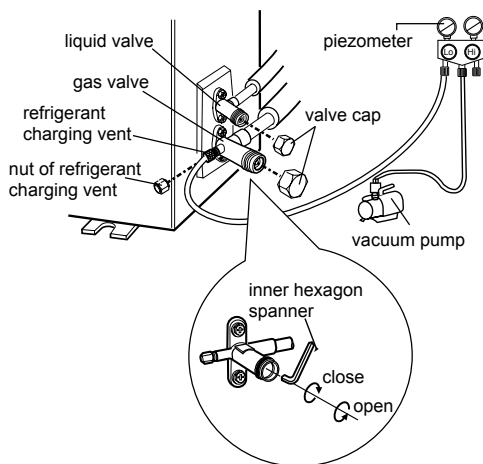

## Step 8: Leakage detection

### 1. With leakage detector:

Check if there is leakage with leakage detector.

### 2. With soap water:

If leakage detector is not available, please use soap water for leakage detection.

Apply soap water at the suspected position and keep the soap water for more than 3min. If there are air bubbles coming out of this position, there's a leakage.

# Check after installation

Check according to the following requirement after finishing installation.

Items to be checked	Possible malfunction
Has the unit been installed firmly?	The unit may drop, shake or emit noise.
Have you done the refrigerant leakage test?	It may cause insufficient cooling (heating) capacity.
Is heat insulation of pipeline sufficient?	It may cause condensation and water dripping.
Is water drained well?	It may cause condensation and water dripping.
Is the voltage of power supply according to the voltage marked on the nameplate?	It may cause malfunction or damaging the parts.
Is electric wiring and pipeline installed correctly?	It may cause malfunction or damaging the parts.
Is the unit grounded securely?	It may cause electric leakage.
Does the power cord follow the specification?	It may cause malfunction or damaging the parts.
Is there any obstruction in the air inlet and outlet?	It may cause insufficient cooling(heating) capacity.
The dust and sundries caused during installation are removed?	It may cause malfunction or damaging the parts.
The gas valve and liquid valve of connection pipe are open completely?	It may cause insufficient cooling(heating) capacity.

# Test operation

## 1. Preparation of test operation

- The client approves the air conditioner.
- Specify the important notes for air conditioner to the client.

## 2. Method of test operation

- Connect the power, press "ON/OFF" button on the remote controller to start operation.
- Press "MODE" button to select AUTO, COOL, DRY, FAN and HEAT to check whether the operation is normal or not.
- If the ambient temperature is lower than 16°C, the air conditioner can't start cooling.

# Configuration of connection pipe

1. Standard length of connection pipe
  - 5m, 7.5m, 8m.
2. Min. length of connection pipe is 3m.
3. Max. length of connection pipe and max. high difference.

Cooling capacity	Max length of connection pipe	Max height difference	Cooling capacity	Max length of connection pipe	Max height difference
5000Btu/h (1465W)	15	5	24000Btu/h (7032W)	25	10
7000Btu/h (2051W)	15	5	28000Btu/h (8204W)	30	10
9000Btu/h (2637W)	15	5	36000Btu/h (10548W)	30	20
12000Btu/h (3516W)	20	10	42000Btu/h (12306W)	30	20
18000Btu/h (5274W)	25	10	48000Btu/h (14064W)	30	20

4. The additional refrigerant oil and refrigerant charging required after prolonging connection pipe
  - After the length of connection pipe is prolonged for 10m at the basis of standard length, you should add 5ml of refrigerant oil for each additional 5m of connection pipe.
  - The calculation method of additional refrigerant charging amount (on the basis of liquid pipe): **Additional refrigerant charging amount = prolonged length of liquid pipe × additional refrigerant charging amount per meter**
  - Basing on the length of standard pipe, add refrigerant according to the requirement as shown in the table. The additional refrigerant charging amount per meter is different according to the diameter of liquid pipe. See the following sheet.

Additional refrigerant charging amount for R32

Diameter of connection pipe		Outdoor unit throttle	
Liquid pipe(mm)	Gas pipe(mm)	Cooling only(g/m)	Cooling and heating(g/m)
Φ6	Φ9.52 or Φ12	12	16
Φ6 or Φ9.52	Φ16 or Φ19	12	40
Φ12	Φ19 or Φ22.2	24	96
Φ16	Φ25.4 or Φ31.8	48	96
Φ19	-	200	200
Φ22.2	-	280	280

# Pipe expanding method

Improper pipe expanding is the main cause of refrigerant leakage. Please expand the pipe according to the following steps:

## A: Cut the pipe

Confirm the pipe length according to the distance of indoor unit and outdoor unit. Cut the required pipe with pipe cutter.

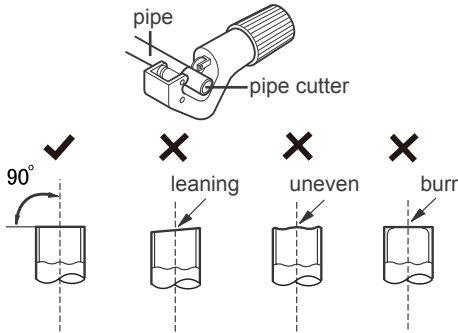

## B: Remove the burrs

Remove the burrs with shaper and prevent the burrs from getting into the pipe.

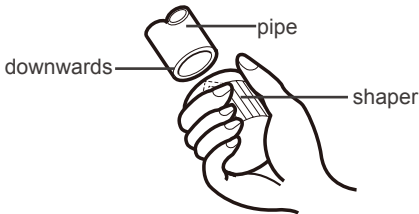

## C: Put on suitable insulating pipe

## D: Put on the union nut

Remove the union nut on the indoor connection pipe and outdoor valve; install the union nut on the pipe.

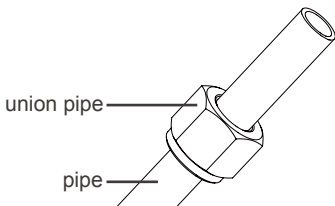

## E: Expand the port

Expand the port with expander.

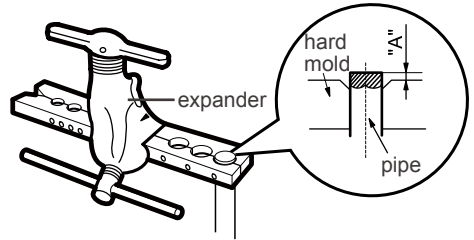

### Note:

- "A" is different according to the diameter, please refer to the sheet below:

Outer diameter(mm)	A(mm)	
	Max	Min
Φ6 - 6.35(1/4")	1.3	0.7
Φ9.52(3/8")	1.6	1.0
Φ12-12.7(1/2")	1.8	1.0
Φ15.8-16(5/8")	2.4	2.2

## F: Inspection

Check the quality of expanding port. If there is any blemish, expand the port again according to the steps above.

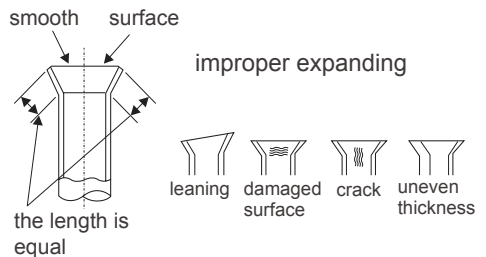



# Operation guide

## Installation batteries

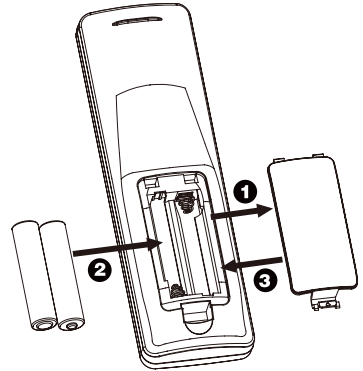
1. Press the back side of remote controller marked with "  ", as shown in the fig, and then push out the cover of battery box along the arrow direction.
2. Installation two 7# (AAA 1.5V) dry batteries, and make sure the position of "+" polar and "-" polar are correct.
3. Reinstall the cover of battery box.



## Operation guide

1. After connecting the power, press "  " button on remote controller to turn on the air conditioner.
2. Press "MODE" button to select your required mode: Auto, Cool, Dry, Fan, Heat.
3. Press "  " or "  " button to set your required temperature. (Temperature can't be adjusted under auto mode).
4. Press "FAN" button to set your required fan speed: auto , quiet , fan1 , fan2 , fan3 , fan4 , fan5 , turbo,stepless speed,.
5. Press "SWING" button to turn on or turn off the swing function.

### **NOTE:**

- During operation, point the remote control signal sender at the receiving window on indoor unit.
- The distance between signal sender and receiving window should be no more than 8m, and there should be no obstacles between them.
- Signal may be interfered easily in the room where there is fluorescent lamp or wireless telephone; remote controller should be close to indoor unit during operation.
- Replace new batteries of the same model when replacement is required.
- When you don't use remote controller for a long time, please take out the batteries.
- If the display on remote controller is fuzzy or there's no display, please replace batteries.

# Remote controller

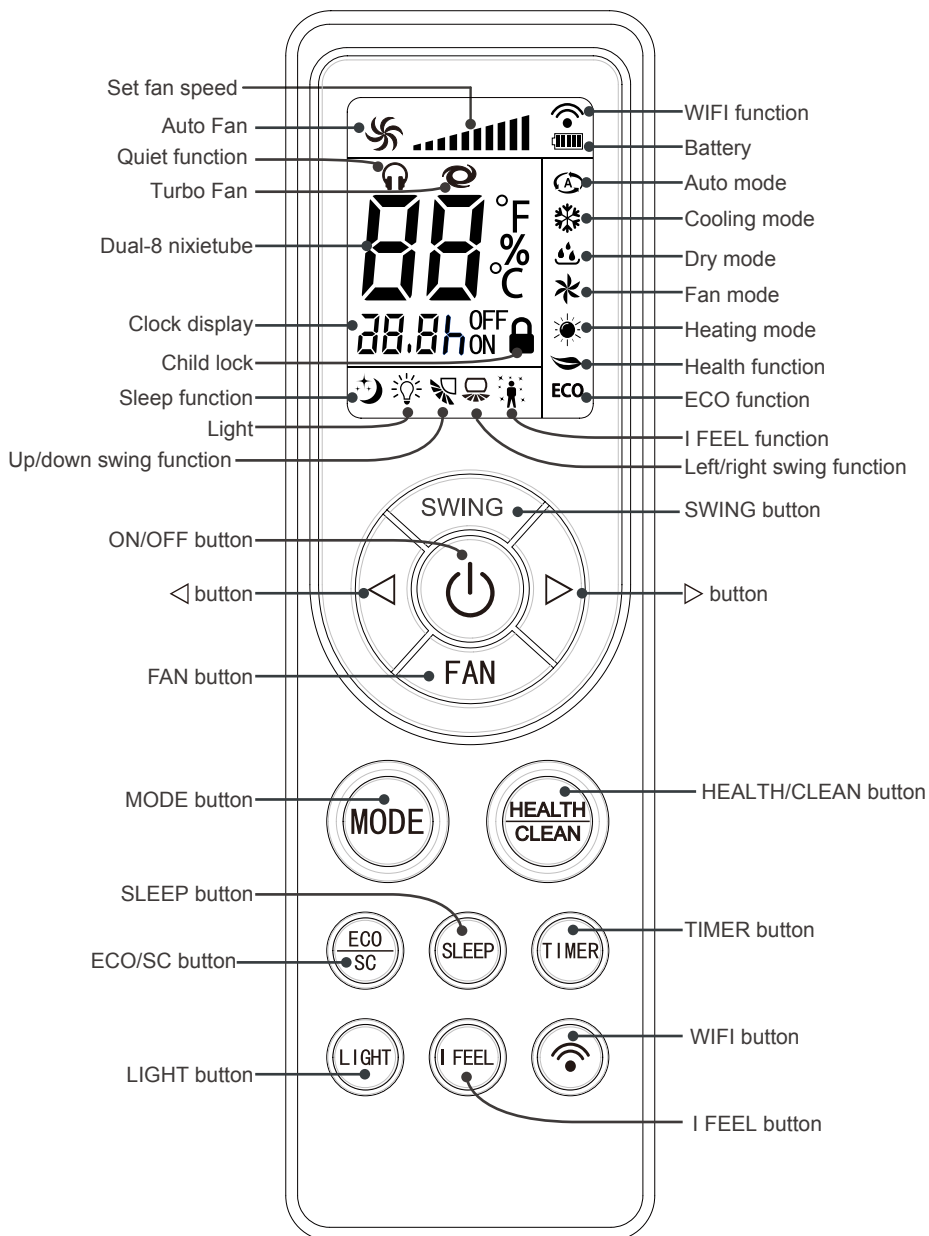

# Buttons on remote controller

After connecting the power, the air conditioner will make a sound.

Power indicator is ON. After that, you can operate the air conditioner by using remote controller.

In state of turning on, pressing the button on the remote controller, the air conditioner will make a "beep" sound, which means the signal has been sent to the air conditioner. The display will show the corresponding setting function icons.

In state of turning off, light icon will be displayed on the display of remote controller (If timer on and light functions are set, the corresponding icons will be displayed on the display of remote controller at the same time).

## ON/OFF button

Press this button to turn on or turn off the air conditioner.

## MODE button

Press this button to select your required operation mode. You can select Auto, Cool, Dry, Fan and Heat mode.



- When selecting auto mode, air conditioner will operate automatically according to ex-factory setting. Setting temperature can't be adjusted and will not be displayed as well. Press "FAN" button can adjust fan speed. Press "SWING" button turn on or turn off the swing function.
- When selecting cool mode, air conditioner will operate under cooling mode. Press " $\triangleleft$ " or " $\triangleright$ " button to adjust setting temperature. Press "FAN" button to adjust fan speed. Press "SWING" button to turn on or turn off the swing function.
- When selecting dry mode, the air conditioner will operate in fan1, fan speed can't be adjusted. Press "SWING" button to turn on or turn off the swing function.
- When selecting fan mode, the air conditioner will only blow, no cooling and no heating. Press "FAN" button to adjust fan speed. Press "SWING" button to turn on or turn off the swing function.
- When selecting heat mode, the air conditioner will operate in heating mode. Press " $\triangleleft$ " or " $\triangleright$ " button to adjust setting temperature. Press "FAN" button to adjust fan speed. Press "SWING" button to turn on or turn off the swing function. (Cooling only unit won't receive heat mode signal. If setting heating mode with remote controller, press ON/OFF button can't start up the unit).

### *Note:*

- To preventing cold air, after starting up heating mode, indoor unit will delay 1~5 minutes to blow air (actual delay time is depend on indoor ambient temperature).
- Setting temperature range from remote controller: 16~31°C;  
Fan speed: auto, quiet, fan1, fan2, fan3, fan4, fan5, turbo, stepless speed.

# Buttons on remote controller

## ▷ button

- In non-auto mode, press this button to increase the set temperature;
- Press and hold down this button for more than 0.5 seconds, set the temperature to change quickly, the °C(°F) icon is displayed all the time during the process, the temperature upper limit is 31°C(88°F).

## ◁ button

- In non-auto mode, press this button to decrease the set temperature;
- Press and hold down this key for more than 0.5 seconds, set the temperature to change rapidly, the °C(°F) icon is displayed all the time during the process, the default temperature limit is 16°C(61°F).

## FAN button

- Press this button to set fan speed circularly: auto, quiet, fan1, fan2, fan3, fan 4, fan 5, turbo, stepless speed.
- Dry mode can only be set to low fan speed.
- No turbo fan speed under auto mode.
- No quiet fan speed under fan mode.
- Under auto fan speed, remote control display  , fan speed display circularly between grid 1 to 5.

### *Note:*

In the stepless speed mode:

- Press the ◁/▷ button to modify the fan speed setting value.
- Long press ◁/▷ key 0.5 second after the rapid change of fan speed , digital fan speed display;
- Press FAN button to switch to other fan speeds during 5s timing, press FAN button again to enter stepless speed after 5s timing.

## ECO/SC button

In the state of cooling mode, press "ECO/SC" button, to select ECO function, LCD display icon"ECO".

- Switch modes cancels ECO function. Turn off remote control and start again, ECO function reserved;
- The default fan speed is auto fan speed, the fan speed and setting temperature is non-adjustable.
- Sleep and ECO function cannot start at the same time.

### *Note:*

- Long press the "ECO/SC" button in any state, the remote control display "SC" and enter the off state. Remote control sends self-cleaning information.
- Under the SC state, turn on the machine by remote to exit SC state.

# Buttons on remote controller

## TIMER button

- Timing time range 0.5~24 hours, timing scale 0.5 hour.
- Press the TIMER button to set the timing on, LCD display "0.0", "h ON" flashing, After 5s, no operation default no timing. Timing time can be adjusted within 5s by pressing "<" or ">" button. After setting the timing time, press the TIMER button to determine the timing time. When adjusting the timing, long press for more than 0.5 seconds "<" or ">" button, time setting changes quickly.
- Press the TIMER button to set the timing off. The setting method refers to the timing on.

## WIFI button

- Press this button to turn on or turn off WIFI function.
- Press this button more than 2s to enter WIFI configuration mode.
- For more details, please see for Smart APP user manual.

## SLEEP button

- Press this button to turn on or turn off the SLEEP function under cool, heat and dry mode.
- Power on the machine, the default is sleep OFF; after setting sleep function, the sleep icon is displayed.
- Turn off the machine and switch modes to cancel the sleep function.
- It is no use under "FAN" mode and "AUTO" mode.

## LIGHT button

- Press this button, switch between LIGHT On and LIGHT Off for indoor unit's display.
- Power on the machine, the default is light on, and light icon displays.
- When the light is on, the display board displays environment temperature for 3 seconds and then display the setting temperature.

## SWING button

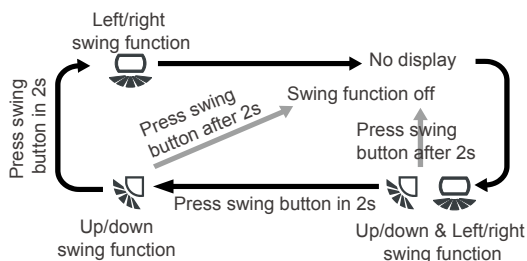

- Long press this button to suspend all swings, long press again the button to continue the previous state

### *Note:*

- If there is no this function for the unit. Press this button, the unit will sound, but it runs under original state.

# Buttons on remote controller

## HEALTH/CLEAN button

- Press this button to turn on and turn off the HEALTH function.
- First power on the machine, HEALTH/CLEAN default is open, use remote control to turn on the machine or switch modes, HEALTH/CLEAN function maintains the original state.  
Note: This function is not available for some models.

### CLEAN Function:

- It is unable to set CLEAN function when the unit is on. If the air conditioner run in cool or dry mode before turning off, after turning off the air conditioner, long pressing this button to turn on CLEAN function, the screen displays "CL", by running for 10 mins in CLEAN function then turn off automatically, or long pressing again this button to turn off CLEAN function, "CL" disappear.
- Power on the remote control, CLEAN function default is off.
- The CLEAN function cannot be set and displayed when the air conditioner is in AUTO, FAN and HEAT mode before turning off the air conditioner.

## I FEEL button

Press this button, you can select the I FEEL function on and off. The first power on, I FEEL function default is off. Press this button, I FEEL icon appear and I FEEL function is on, press this button again, close the I FEEL function and I FEEL icon disappear.

### *Note:*

Please put the remote controller near user and confirm the unit can receive the remote code. when this function is set. Do not put the remote controller near the object of high temperature. or low temperature in order to avoid detecting inaccurate ambient temperature.

## *Introduction to the function of combination Buttons:*

### **Child lock setting and unlocking**

- In the state of turning on or turning off the machine, hold down the "◀" button and "▶" button at the same time, enter the "Child lock" function to lock or unlock the remote control buttons, after locking, the CHILD lock icon is displayed. At this time, by operating any button, the CHILD lock icon will blink three times without sending signal to the unit.
- After unlocking the buttons, the CHILD lock icon is not displayed. After powered on, the default is unlock.

### **F and C temperature switch**

In the state of turning off, holding down the "MODE" and "◀" button, switch between °C and °F.

# Buttons on remote controller

## Low temperature heating function setting

In heating mode, press the "MODE" and "▷" button at the same time will enter/exit the low temperature heating function.

- "LA" icon is showed on the remote after entered into the low temperature heating function, fan speed is default to Auto and non-adjustable.
- When switching from one mode to another mode, low temperature heating function is cancelled. Turn off and then turn on air conditioner that will remain the low temperature heating function. After powered on, the low temperature heating mode is defaulted off state.
- In the low temperature heating mode, "SLEEP" function and "Low temperature heating" function cannot start at the same time.
- After entering the low temperature heating function, to cancel the QUIET or TURBO function, after the exit will be restored to the state before entering.

# Clean and maintenance

## **WARNING**

- Turn off the air conditioner and disconnect the power before cleaning the air conditioner to avoid electric shock.
- Do not wash the air conditioner with water to avoid electric shock.
- Do not use volatile liquid to clean the air conditioner.

### Clean surface of indoor unit

When the surface of indoor unit is dirty, it is recommended to use a soft dry cloth or wet cloth to wipe it.

#### *Note:*

Do not remove the panel when cleaning it.

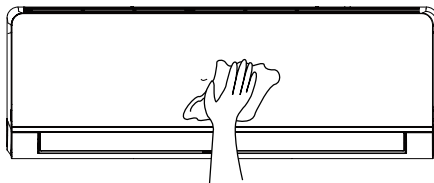

### Clean filter

#### **1** Open panel

Pull out the panel to a certain angle as shown in the fig.

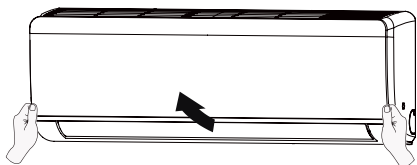

#### **2** Remove filter

Remove the filter as indicated in the fig.

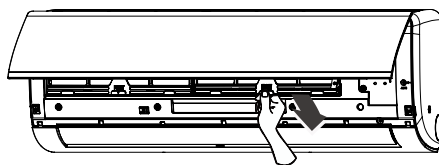

#### **3** Clean filter

Use dust catcher or water to clean the filter. When the filter is very dirty, use the water (below 45°C) to clean it, and then put it in a shady and cool place to dry.

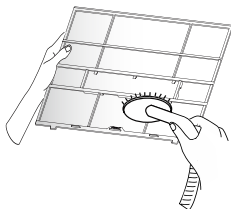

#### **4** Installation filter

Installation the filter and then close the panel cover tightly.

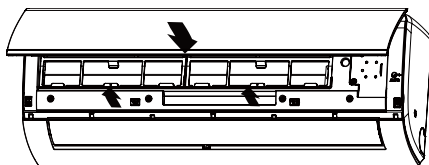

# Clean and maintenance

## **NOTE:**

- The filter should be cleaned every three months. If there is much dust in the operation environment, clean frequency can be increased.
- After removing the filter, do not touch fins to avoid injury.
- Do not use fire or hair dryer to dry the filter to avoid deformation or fire hazard.

## **Checking before use-season**

1. Check whether air inlets and air outlets are blocked.
2. Check whether air switch, plug and socket are in good condition.
3. Check whether filter is clean.
4. Check whether drainage pipe is damaged.

## **Checking after use-season**

1. Disconnect power supply.
2. Clean filter and indoor unit's panel .

## **Notice for recovery**

1. Most of packing materials are recyclable materials.  
Please dispose them in appropriate recycling unit.
2. If you want to dispose the air conditioner, please contact local dealer or consultant service center for the correct disposal method.

# Malfunction analysis

## General phenomenon analysis

Please check below items before asking for maintenance. If the malfunction still can't be eliminated, please contact local dealer or qualified professionals.

Phenomenon	Check items	Solution
Indoor unit can't receive remote controller's signal or remote controller has no action.	Whether it's interfered severely (such as static electricity, stable voltage)?	Pull out the plug. Reinsert the plug after about 3min, and then turn on the unit again.
	Whether remote controller is within the signal receiving range?	Signal receiving range is 8m.
	Whether there are obstacles?	Remove obstacles.
	Whether remote controller is pointing at the receiving window?	Select proper angle and point the remote controller at the receiving window on indoor unit
	Is sensitivity of remote controller low; fuzzy display and no display?	Check the batteries. If the power of batteries is too low, please replace them.
	No display when operating remote controller?	Check whether remote controller appears to be damaged. If yes, replace it.
	Fluorescent lamp in room?	Take the remote controller close to indoor unit. Turn off the fluorescent lamp and then try it again.
No air emitted from indoor unit.	Air inlet or air outlet of indoor unit is blocked?	Eliminate obstacles.
	Under heating mode, indoor temperature is reached to set temperature?	After reaching to set temperature, indoor unit will stop blowing out air.
	Heating mode is turned on just now?	In order to prevent blowing out cold air, indoor unit will be started after delaying for several minutes, which is a normal phenomenon.
Air conditioner can't operate	Power failure?	Wait until power recovery.
	Is plug loose?	Reinsert the plug.
	Circuit break trips off or fuse is burnt out?	Ask professional to replace circuit break or fuse.
	Wiring has malfunction?	Ask professional to replace it
	Unit has restarted immediately after stopping operation?	Wait for 3min, and then turn on the unit again.
	Whether the function setting for remote controller is correct?	Reset the function.

# Malfunction analysis

Phenomenon	Check items	Solution
Mist is emitted from indoor unit's air outlet.	Indoor temperature and humidity is high?	Because indoor air is cooled rapidly. After a while, indoor temperature and humidity will be decrease and mist will disappear.
Set temperature can't be adjusted	Unit is operating under auto mode?	Temperature can't be adjusted under auto mode. Please switch the operation mode if you need to adjust temperature.
	Your required temperature exceeds the set temperature range?	Set temperature range: 16℃ ~31℃
Cooling (heating) effect is not good.	Voltage is too low?	Wait until the voltage resumes normal.
	Filter is dirty?	Clean the filter.
	Set temperature is in proper range?	Adjust temperature to proper range.
	Door and window are open?	Close door and window.
Odours are emitted	Whether there's odour source, such as furniture and cigarette, etc.	Clean the filter. Eliminate the odour source.
Air conditioner operates normally suddenly	Whether there's interference, such as thunder, wireless devices, etc.	Disconnect power, put back power, and then turn on the unit again.
Outdoor unit has vapor	Heating mode is turned on?	During defrosting under heating mode, it may generate vapor, which is a normal phenomenon.
"Water flowing" noise	Air conditioner is turned on or turned off just now?	The noise is the sound of refrigerant flowing inside the unit, which is a normal phenomenon.
Cracking noise	Air conditioner is turned on or turned off just now?	This is the sound of friction caused by expansion and/or contraction of panel or other parts due to the change of temperature.

# Malfunction analysis

## Error Code

When air conditioner status is abnormal, temperature indicator on indoor unit will blink to display corresponding error code. Please refer to below list for identification of error code.

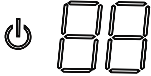

**Note:**

Above indicator diagram is only for reference. Please refer to actual product for the actual indicator and position.

Below listed error codes are only part error codes. Please refer to error code list in service manual for more information.

Error code	Troubleshooting	Solution
CL	Filter filth blockage alert	Power off,clean filter.If the filter is not dirty, turn off the air conditioner for 2s then restart,the code will be removed automatically.
E1	Overheat protection	Turn off,restart after 5min,if the code occurs again after a few minutes, please contact the professional person.
E2	Over current protection	Turn off,restart after 5min,if the code occurs again after a few minutes, please contact the professional person.
HE	Auxiliary heater drive circuit malfunction	Pull out the plug, please contact the professional person.
L0	Jumper malfunction	Pull out the plug, restart after 10s, if the code occurs again , please contact the professional person.
L1	PG motor(indoor)zero-crossing detecting circuit malfunction	Turn off,restart after a few seconds, if the code occurs again after a few minutes, please contact the professional person.
L2	No feedback signal of indoor unit fan	Turn off,restart after a few seconds, if the code occurs again after a few minutes, please contact the professional person.
U0	Short/open circuit of indoor environment sensor	Power off the unit, restart after 10s, if the code occurs again , please contact the professional person.
U1	Short/open circuit of indoor unit tube sensor	Power off the unit, restart after 10s, if the code occurs again , please contact the professional person.

**If there're other error codes, please contact qualified professionals for service.**

## Contact us

When below phenomenon occurs, please turn off air conditioner and disconnect power immediately, and then contact the dealer or qualified professionals for service.

- Power cord is overheating or damaged.
- Air conditioner gives off burning smell.
- There's abnormal sound during operation.
- Circuit break trips off frequently.
- Indoor unit is leaking.

Do not repair or refit the air conditioner by yourself.

If the air conditioner operates under abnormal conditions, it may cause malfunction, electric shock or fire hazard.

